

Solenoid directional valves with low power consumption

Direct operated, ISO 4401 size 06

Available only on request

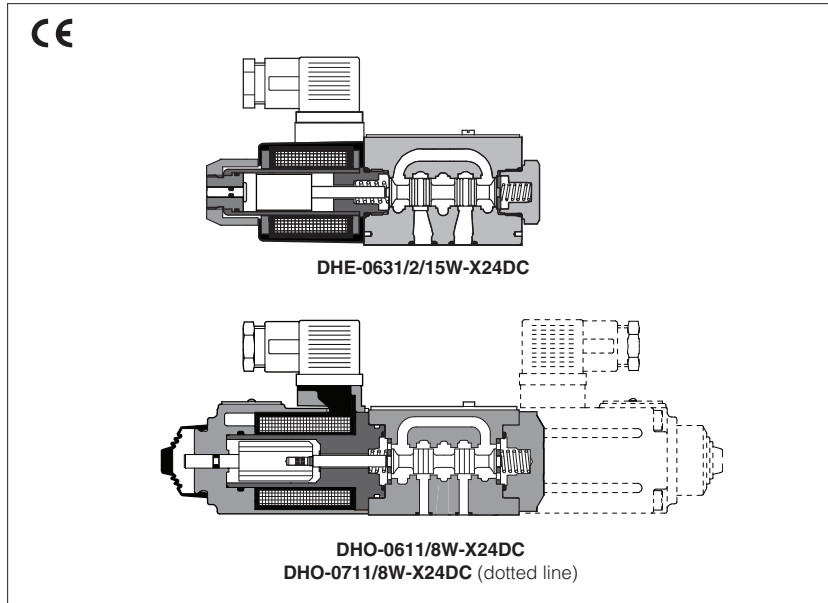

On-off directional valves derived from standard versions and equipped with low power consumption solenoids. They permits a considerable energy saving and they can be directly operated from the output stage of the machine control system (PLC I/O modules)

Two models are available:

- DHE, 15W power, spool type, max operating limits 40 l/min, 210 bar
- DHO, 8W power, spool type, max operating limits 50 l/min, 250 bar

For DHE the coils can be easily replaced without tools. The coils are fully encapsulated according to temperature class H.

Applications

Machine tools, marine system

Surface mounting ISO 4401 size 06

1 MODEL CODE OF SPOOL TYPE DIRECTIONAL VALVES

DHO - 0	61	1	/	8W	/	A	-	X	24DC	**	/*
<p>Directional control valves ISO 4401 size 06 DHE-0 = for DC supply DHO-0 = for DC supply with improved performances</p> <p>Valve configuration, see table 2 61 = single solenoid, center plus external position, spring centered 63 = single solenoid, 2 external positions, spring offset 67 = single solenoid, center plus external position, spring offset 71 = double solenoid, 3 positions, spring centered Other configurations are available on request</p> <p>Spool type, see table 2</p> <p>Solenoid power 15W = for DHE 8W = for DHO</p>											<p>Seals material - = NBR PE = FKM</p> <p>Series number</p>
											<p>Voltage code 24DC = 24Vdc</p>
											<p>X = without connector See note 1 at section 2 for available connectors, to be ordered separately</p>
											<p>Options A = Solenoid mounted at side of port B (only for single solenoid valves). In standard versions, solenoid is mounted at side of port A.</p>

2 CONFIGURATIONS and SPOOLS

Configurations	Spools	Configurations	Spools
<p>61</p> <p>61/A</p> <p>67</p> <p>67/A</p> <p>71</p>	<p>1 0 2 1 0 2 1 0 2 1 0 2</p> <p>0</p> <p>1</p> <p>3</p> <p>4</p> <p>5</p> <p>6</p> <p>7</p> <p>8</p> <p>16</p> <p>17</p> <p>58</p>	<p>63</p> <p>63/A</p>	<p>1 0 2</p> <p>0/2</p> <p>1/2</p> <p>2/2</p>

3 MAIN CHARACTERISTICS OF DHE /15W AND DHO /8W DIRECTIONAL VALVES

Assembly position / location	Any position
Subplate surface finishing	Roughness index Ra 0,4 - flatness ratio 0,01/100 (ISO 1101)
Ambient temperature	from -20°C to +70°C
Fluid	Hydraulic oil as per DIN 51524 535; for other fluids see section 1
Recommended viscosity	15 ÷ 100 mm ² /s at 40°C (ISO VG 15 ÷ 100)
Fluid contamination class	ISO 4401 class 21/19/16 NAS 1638 class 10, in line filters of 25 µm (β ₂₅ ≥ 75 recommended)
Fluid temperature	-20°C +60°C (standard seals) -20°C +80°C (/PE seals)
Flow direction	As shown in the symbols of tables 2
Operating pressure	DHE, DHO Ports P,A,B: 350 bar ; Port T: 210 bar
Rated flow	See diagrams Q/Δp at section 5
Maximum flow	40 l/min for DHE; 50 l/min for DHO; see operating limits at section 6

3.1 Coils characteristics

Insulation class	H (180°C) Due to the occurring surface temperatures of the solenoid coils, the European standards EN ISO 13732-1 and EN ISO 4413 must be taken into account
Connector protection degree DIN 43650	IP 65
Relative duty factor	100%
Supply voltage tolerance	± 10%

4 NOTES

1 Type of electric/electronic connector DIN 43650, to be ordered separately

666 = standard connector IP-65, suitable for direct connection to electric supply source.

667 = as 666, but with built-in signal led.

2 Spools

- spools type **0/2**, **1/2** and **2/2** are only used for two position valves: single solenoid valves, type DH*-063*/2

5 Q/ΔP DIAGRAMS based on mineral oil ISO VG 46 at 50°C

Flow direction Spool type	PØA	PØB	AØT	BØT	PØT
0, 0/1, 6, 7, 8	A	A	A	A	B
0/2, 1, 1/2, 2, 3	B	B	B	B	
4, 5	D	D	C	C	D
2/2	E	E			

Based on fluid viscosity of 43 mm²/s at 40°C.

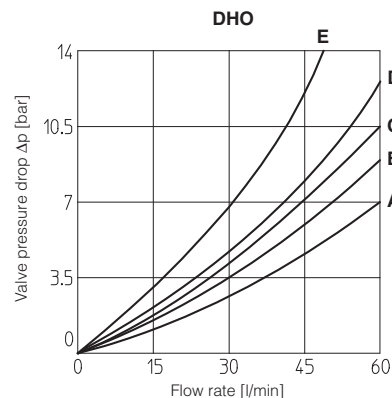
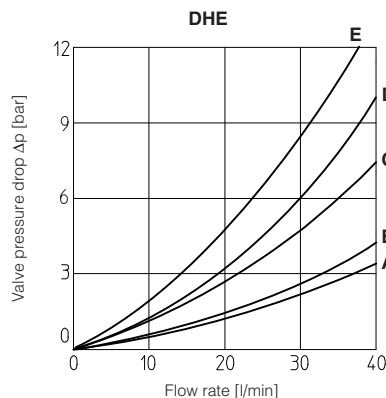

6 OPERATING LIMITS

The diagrams have been obtained with warm solenoids and power supply at lowest value (V_{nom} - 10%). The curves refer to application with symmetrical flow through the valve (i.e. PØA and BØT). In case of asymmetric flow the operating limits must be reduced.

DHE, DHO

- A** = Spools 0, 1, 1/2, 8
- B** = Spools 0/2, 3, 6, 7
- C** = Spools 4, 5, 58, 16, 17
- D** = Spools 2/2

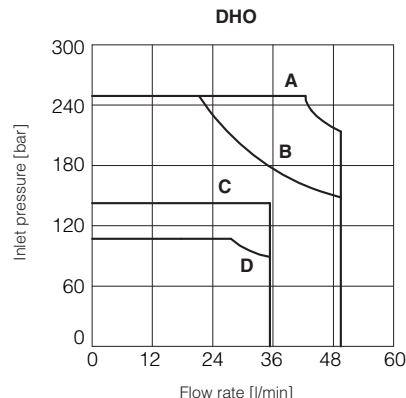
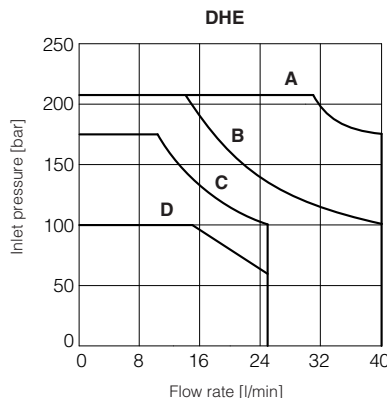

7 DIMENSIONS [mm]

ISO 4401: 2005

Mounting surface: 4401-03-02-0-05

Fastening bolts:

DHE: 4 socket head screws M5x30 class 12.9

DHO: 4 socket head screws M5x50 class 12.9

Tightening torque = 8 Nm

Seals: 4 OR 108

Ports P,A,B,T: $\varnothing = 7.5$ mm (max).

Overall dimensions refer to valves with connectors type 666

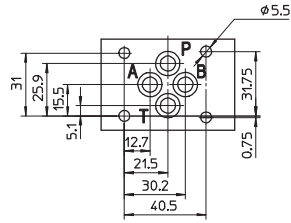

P = PRESSURE PORT

A, B = USE PORT

T = TANK PORT

For the max pressures on ports, see section 5

DHE-06

Option /WP

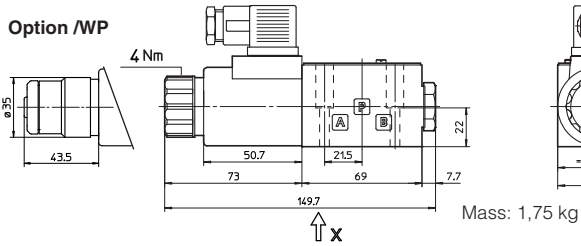

DHE-07

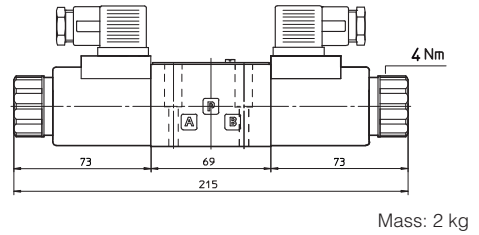

DHO-06

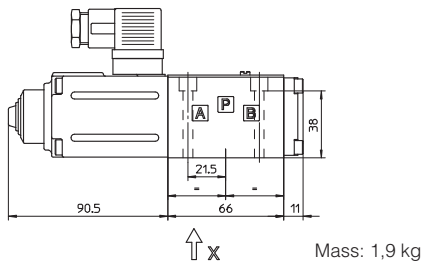

DHO-07

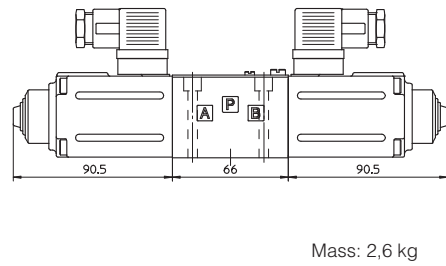

8 MOUNTING SUBPLATES

Model	Ports location	GAS Ports A-B-P-T	\varnothing Counterbore [mm] A-B-P-T	Mass [kg]
BA-202	Ports A, B, P, T underneath;	3/8"	-	1,2
BA-204	Ports P, T underneath; ports A, B on lateral side	3/8"	25,5	1,8
BA-302	Ports A, B, P, T underneath	1/2"	30	1,8

The subplates are supplied with 4 fastening bolts M5x50. Also available are multi-station subplates and modular subplates. For further details see table K280.