

Mitutoyo

Mitutoyo Quality

PH-3515F PROFILE PROJECTOR

Heavy-Duty, Bench-Top Model with Horizontal Optical System

OPTICAL MEASURING

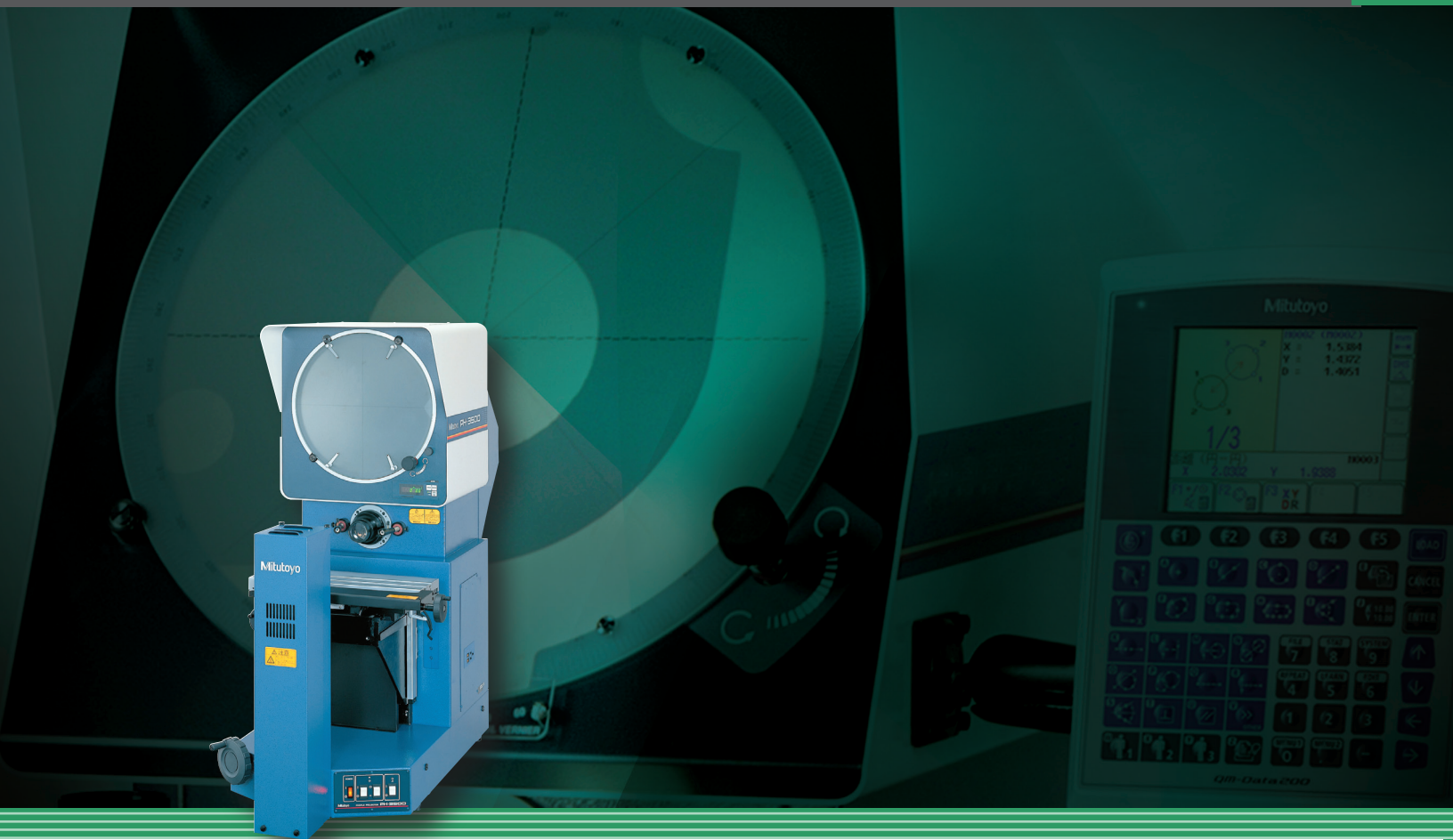



Mitutoyo introduces the PH-3515F

Profile Projectors that will meet any optical measuring or inspection challenge your shop can offer!

FEATURES

- Erect image on high brightness screen.
- 14" (353mm) dia. protractor screen with crosshairs and staggered lines for easy alignment.
- Digital angle measurement of 1' or 0.01° with built in angle counter.
- Floating-type workstage incorporates linear scales for fast, accurate measurement.
- Halogen contour illumination.
- Fiber-optic illumination cables and halogen included.
- Suitable for thread pitch measurements — free from blurred or distorted images when the workpiece is angled.
- Wide range of accessories for varied applications.



Also available:
Optional side mount surface illumination unit (172-423)

DIMENSIONS

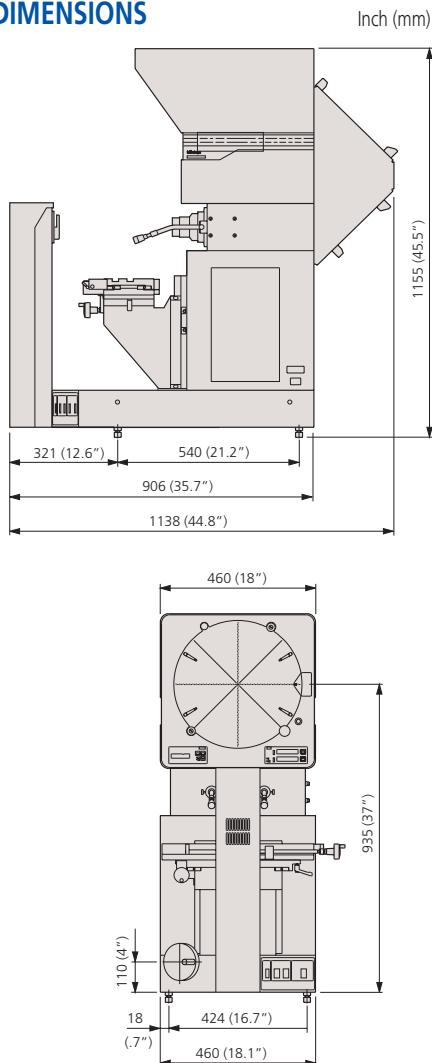

SPECIFICATIONS

Model No.	PH-3515F	
Order No.	172-868A	
Projected Image	Erect image	
Protractor screen	Effective diameter	14" / 353mm
	Screen material	Fine ground glass
	Reference line	Cross hair line
	Screen rotation	±360°, fine feed and clamp
	Angle display(LED)	Resolution: 1' or 0.01°(switchable), Range: ±370°, Functions: Absolute/incremental mode switching, Zero set
Projection lens	Standard accessory: 10x(172-184), Optional accessories: 5X, 20X, 50X, 100X	
Magnification accuracy	Contour illumination	±0.1% or less
	Surface illumination	±0.15% or less
Contour illumination	light source	Halogen bulb (24V 150W)
	Optical system	Telecentric system
	Functions	2-step brightness switch, Heat-absorbing filter, Cooling fan
Surface illumination (Optional accessories)	light source	Halogen bulb(24V 150W)
	Functions	Adjustable condenser lens. Heat-absorbing filter, Cooling fan
	Table travel (X-axis)	10" / 254mm
Table size (X, Z)	17.7"x5.7" / 450x146mm	
Vertical travel (Y-axis)	6" / 152mm	
Resolution	0.001mm/.00005"*	
Measuring Unit	Built in Linear scale	
XY Stage	Max. workpiece width	See (L) on page I-10
	Max. workpiece load	100lbs / 45kg
Power supply	120V AC, 50/60Hz	
Mass	333lbs / 150kg	
Standard accessories	10x projection lens set, work stage, power cord, halogen bulb, tube fuse, grounding wire, allen wrench, Vinyl cover	

* Counter not included

SYSTEM DIAGRAM

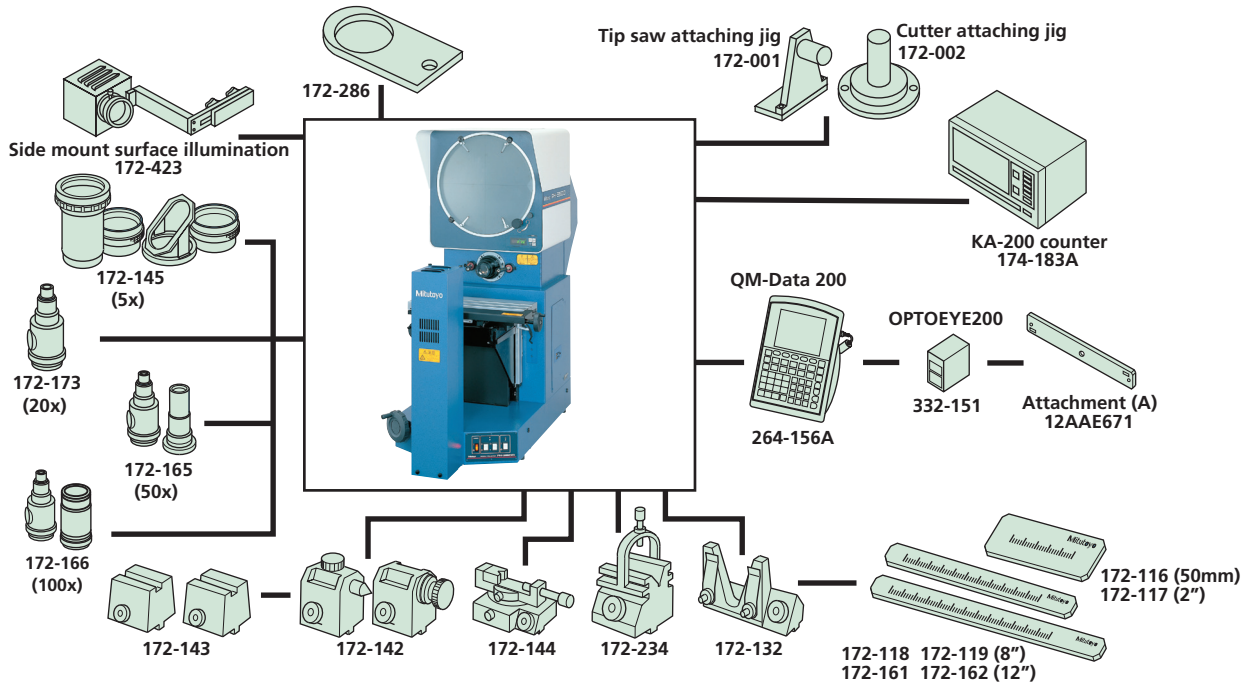

ACCESSORIES

Projection Lenses



Projection Capacity

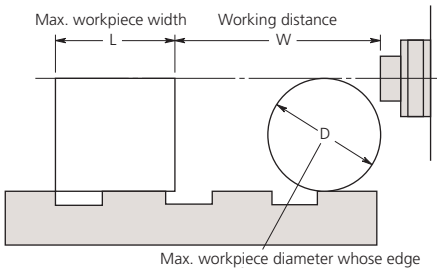

PH-3515F

Unit: mm

	Magnification				
	5X	10X	20X	50X	100X
View field	70.6	35.3	17.65	7.06	3.5
L	175	235	235	80	109
W	160 (64)	93 (35)	40	14.6	9.5
D	152.4	152.4	116	30.4	19

(): When using surface illumination

Workstage

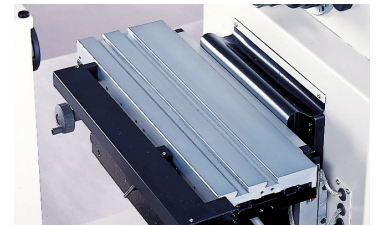

XY range	X-axis (horizontal travel): 10" (254mm)
Y-axis (vertical travel): 6" (152mm)	
Measuring unit	Linear Scale for each axis (AT100 Series)
Display unit	(Optional)
Stage size (WxD)	17.72"x5.75" (450x146mm)
Swivel range	±10° (30' readout)
Max. workpiece load	99 lbs. (45kg)
Dovetail groove	Two (Pitch= 1.69" (43mm))
Focusing travel	2" (50mm)



QM-Data200
2-D data processing unit.
264-155A: Stand mount type
264-156A: Arm mount type

KA-200 Counter: 174-183A
64AAB149: Counter stand



332-151: Optoeye
Edge detection system for QM-Data 200
12AAE671: Detector attachment (A)

See page 4 for additional optional accessories

Optional Accessories

- 172-184: 10X projection lens (standard accessory)
- 172-173: 20X projection lens
- 172-165: 50X projection lens set
- 172-166: 100X projection lens set
- 172-116: Standard scale (50mm)
- 172-117: Standard scale (2")
- 172-118: Reading scale (200mm)
- 172-161: Reading scale (300mm)
- 172-119: Reading scale (8")
- 172-162: Reading scale (12")
- 172-286: Green filter
- 512305: Halogen bulb (24V, 150W) (standard accessory)

Fixture and Stage accessories

- 172-142: Center support
- 172-143: Center support riser
- 172-144: Rotary vise
(Max. workpiece dia.: 2.4" / 60mm)
- 172-234: V-block with clamp
(Max. workpiece dia.: 2" / 50mm)
- 172-132: Vertical holder
- 64AAB176: Machine stand 22"W x 25" D x 26"H

Stand

- 64AAB176
Locking door
22"W x 25"H x 29"D



Center Support

- 172-142
Clamps a cylindrical workpiece such as a screw
Workpiece dia.: 120mm max



Center Support Riser

- 172-143
Widens the damping capacity of the center support to a maximum diameter of 240mm.

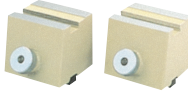

Reading Scales

- 172-118 (200mm)
 - 172-161 (300mm)
 - 172-119 (8")
 - 172-162 (12")
- Designed for checking the magnified image of a standard scale.



Rotary Vise

- 172-144
Workpiece dia.: 60mm max



Vertical Holder

- 172-132
Set up a thin workpiece easily

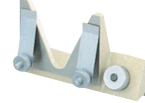

Standard Scales

- 172-116 (50mm)
 - 172-117 (2")
- Used for checking magnifying accuracy.



V-Block w/ Clamp

- 172-234
Workpiece dia.: 50mm max



Green Filter

- 172-286
Increases the screen sharpness of the contour image.

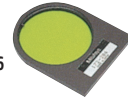

Coordinate Measuring Machines

Vision Measuring Systems

Form Measurement

Optical Measuring

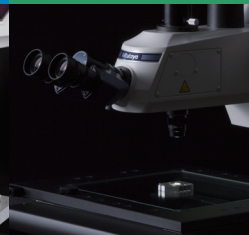

Sensor Systems

Test Equipment and Seismometers

Digital Scale and DRO Systems

Small Tool Instruments and Data Management

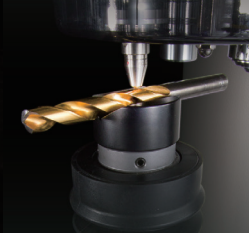

Whatever your challenges are, Mitutoyo supports you from start to finish.

Mitutoyo is not only a manufacturer of top-quality measuring products but one that also offers qualified support for the lifetime of the equipment, backed by comprehensive services that ensure your staff can make the very best use of the investment.

Apart from the basics of calibration and repair, Mitutoyo offers product and metrology training, as well as IT support for the sophisticated software used in modern measuring technology. We can also design, build, test and deliver measuring solutions and even, if deemed cost-effective, take your critical measurement challenges in-house on a sub-contract basis.

Note: All information regarding our products, and in particular the illustrations, drawings, dimensional and performance data contained in this printed matter as well as other technical data are to be regarded as approximate average values. We therefore reserve the right to make changes to the corresponding designs. The stated standards, similar technical regulations, descriptions and illustrations of the products were valid at the time of printing. In addition, the latest applicable version of our General Trading Conditions will apply. Only quotations submitted by ourselves may be regarded as definitive. Specifications are subject to change without notice.

Mitutoyo products are subject to US Export Administration Regulations (EAR). Re-export or relocation of our products may require prior approval by an appropriate governing authority.

Trademarks and Registrations

Designations used by companies to distinguish their products are often claimed as trademarks. In all instances where Mitutoyo America Corporation is aware of a claim, the product names appear in initial capital or all capital letters. The appropriate companies should be contacted for more complete trademark and registration information.