

Solenoid directional valves type **DKE**

direct, spool type

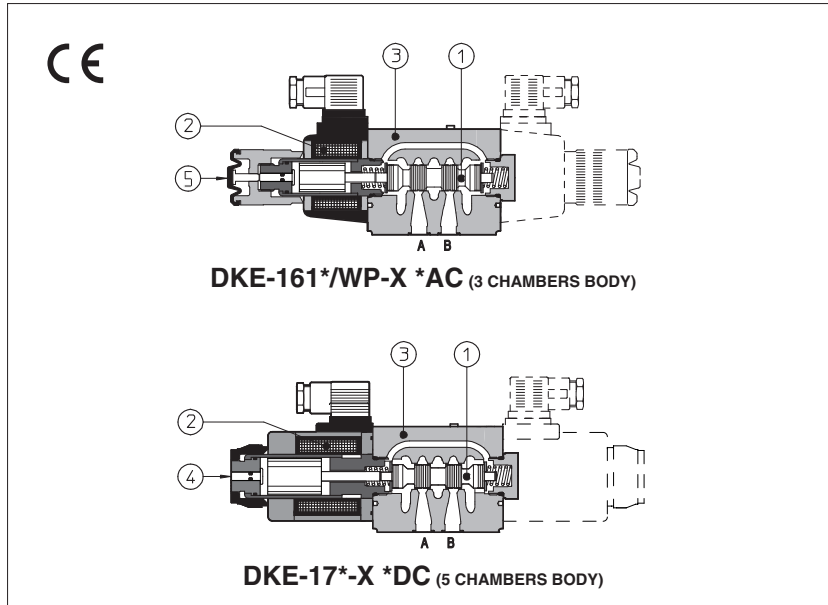

Spool type, two or three position direct operated valves with threaded solenoids certified according to the North American standard **cURus**.

Solenoids (2) are made by:

- wet type screwed tube, different for AC and DC power supply, with integrated manual override pin (4)
- interchangeable coils, specific for AC or DC power supply, easily replaceable without tools - see section 5 for available voltages.

Standard coils protection **IP65**, optional coils with IP67 AMP Junior Timer or lead wire connections.

The valve body (3) is 5 chamber type for all DC versions and for AC safety version /F1 and FV

Standard AC version uses 3 chamber type body.

Wide range of interchangeable spools (1), see section 2.

The body is made by shell-moulding casting with wide internal passages ensuring low pressure drops.

Mounting surface: **ISO 4401 size 10**







Max flow: **150 l/min**

Max pressure: **350 bar**

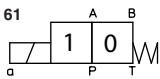
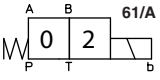
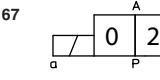
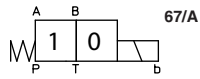
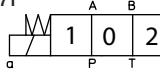
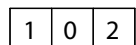
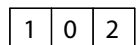
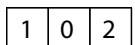
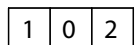
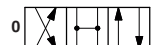
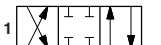
1 MODEL CODE

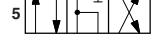
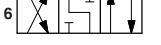
DKE - 1	61	1 / A	- X	24 DC	*	*
Directional control valves size 10					Series number	Seals material, see section 4: - = NBR PE = FKM BT = HNBR
Valve configuration, see section 2	61 = single solenoid, center plus external position, spring centered 63 = single solenoid, 2 external positions, spring offset 67 = single solenoid, center plus external position, spring offset 70 = double solenoid, 2 external positions, without springs 71 = double solenoid, 3 positions, spring centered 75 = double solenoid, 2 external positions, with detent				Voltage code, see section 5	
Spool type, see section 2.						
Options, see note 1 at section 4.						
						00-AC = AC solenoids without coils 00-DC = DC solenoids without coils X = without connector See section 14 for available connectors, to be ordered separately Coils with special connectors, see section 11 XJ = AMP Junior Timer connector XK = Deutsch connector XS = Lead Wire connection

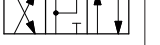
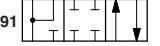
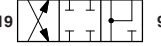
2 CONFIGURATIONS and SPOOLS (representation according to ISO 1219-1)

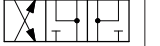
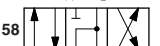
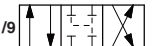
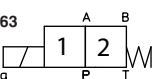
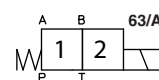
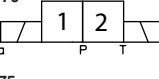
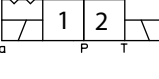
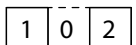
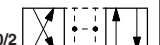
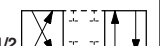
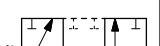
Configurations	Spools	Configurations	Spools
    	                 	   	   
	<p>Note: see also section 4 note 3 for special shaped spools</p>		

3 MAIN CHARACTERISTICS, SEALS AND HYDRAULIC FLUIDS - for other fluids not included in below table, consult our technical office

Assembly position / location	Any position for all valves except for type - 170* (without springs) that must be installed with horizontal axis if operated by impulses		
Subplate surface finishing	Roughness index Ra 0,4 - flatness ratio 0,01/100 (ISO 1101)		
MTTFd values according to EN ISO 13849	150 years, for further details see technical table P007		
Ambient temperature	Standard = -30°C ÷ +70°C	/PE option = -20°C ÷ +70°C	/BT option = -40°C ÷ +70°C
Storage temperature	Standard = -30°C ÷ +80°C	/PE option = -20°C ÷ +80°C	/BT option = -40°C ÷ +80°C
Surface protection	Body: zinc coating with black passivation Coil: zinc nickel coating (DC version) plastic incapsulation (AC version)		
Corrosion resistance	Salt spray test (EN ISO 9227) > 200 h		
Compliance	CE to Low Voltage Directive 2014/35/EU RoHS Directive 2011/65/EU as last update by 2015/863/EU REACH Regulation (EC) n°1907/2006		
Seals, recommended fluid temperature	NBR seals (standard) = -20°C ÷ +80°C, with HFC hydraulic fluids = -20°C ÷ +50°C FKM seals (/PE option)= -20°C ÷ +80°C HNBR seals (/BT option)= -40°C ÷ +60°C, with HFC hydraulic fluids = -40°C ÷ +50°C		
Recommended viscosity	15÷100 mm ² /s - max allowed range 2.8 ÷ 500 mm ² /s		
Max fluid contamination level	ISO4406 class 20/18/15 NAS1638 class 9, see also filter section at www.atos.com or KTF catalog		
Hydraulic fluid	Suitable seals type	Classification	Ref. Standard
Mineral oils	NBR, FKM, HNBR	HL, HLP, HLPD, HVLP, HVLPD	DIN 51524
Flame resistant without water	FKM	HFDU, HFDR	ISO 12922
Flame resistant with water	NBR, HNBR	HFC	
Flow direction	As shown in the symbols of table 2		
Operating pressure	Ports P,A,B: 350 bar; Port T 210 bar for DC version (250 bar with option /Y); 160 bar for AC version		
Rated flow	See diagrams Q/Δp at section 6		
Maximum flow	150 l/min , see operating limits at section 7		

3.1 Coils characteristics

Insulation class	H (180°C) for DC coils F (155°C) for AC coils Due to the occurring surface temperatures of the solenoid coils, the European standards EN ISO 13732-1 and EN ISO 4413 must be taken into account
Protection degree DIN EN 60529	IP 65 (with connectors 666, 667, 669 correctly assembled)
Relative duty factor	100%
Supply voltage and frequency	See electric feature 5
Supply voltage tolerance	± 10%
Certification	cURus North American Standard

4 NOTES

1 Options

- A** = Solenoid mounted at side of port B (only for single solenoid valves). In standard versions, solenoid is mounted at side of port A.
- WP** = prolonged manual override protected by rubber cap - see section 12.
- L, L1, L2, L3, LR, L7, L8** see section 10 = device for switching time control (only for DC solenoids).
L7 and L8 are available only for spool type 0/1, 1/1, 3/1, 4 and 5.
- FI, FV** = versions with proximity switch for spool position monitoring: see tab. EY010.
- Y** = external drain, only for DC version, to be selected if the pressure at T port is higher than the max allowed limits.

2 Accessories

- WPD/KE-DC** = (only for DC supply) manual override with detent, to be ordered separately, see tab. K150

3 Special shaped spools

- spools type **0** and **3** are also available as **0/1** and **3/1** with restricted oil passages in central position, from user ports to tank.
- spool type **1** is also available as **1/1**, properly shaped to reduce the water-hammer shocks during the switching.
- spool type **1/9** has closed center in rest position but it avoids the pressurization of A and B ports due to the internal leakages.

5 ELECTRIC FEATURES

External supply nominal voltage ± 10%	Voltage code	Type of connector	Power consumption (2)	Code of spare coil
12 DC	12 DC	666 or 667	36 W	CAE-12DC
14 DC	14 DC			CAE-14DC
24 DC	24 DC			CAE-24DC
28 DC	28 DC			CAE-28DC
110 DC	110 DC			CAE-110DC
125 DC	125 DC			CAE-125 DC
220 DC	220 DC		CAE-220DC	
110/50/60 AC	110/50/60 AC		100 VA (3)	CAE-110/50/60AC (1)
230/50/60 AC	230/50/60 AC			CAE-230/50/60AC (1)
115/60 AC	115/60 AC		130 VA (3)	CAE-115/60AC
230/60 AC	230/60 AC	CAE-230/60AC		
110/50/60 AC	110 DC	669	36 W	CAE-110DC
230/50/60 AC	220 DC			CAE-220DC

(1) In case of 60 Hz voltage frequency the performances are reduced by 10÷15% and the power consumption is 90 VA

(2) Average values based on tests performed at nominal hydraulic condition and ambient/coil temperature of 20°C.

(3) When solenoid is energized, the inrush current is approx 3 times the holding current.

6 Q/ΔP DIAGRAMS based on mineral oil ISO VG 46 at 50°C

Flow direction Spool type	P→A	P→B	A→T	B→T	P→T	B→A
	0, 0/1, 0/2, 2/2	A	A	B	B	
1, 1/1, 6, 8	A	A	D	C		
3, 3/1, 7	A	A	C	D		
4	B	B	B	B	F	
5, 58	A	B	C	C	G	
1/2	B	C	C	B		
19, 91	F	F	G	G		H
1/9, 39, 93	F	F	G	G		H

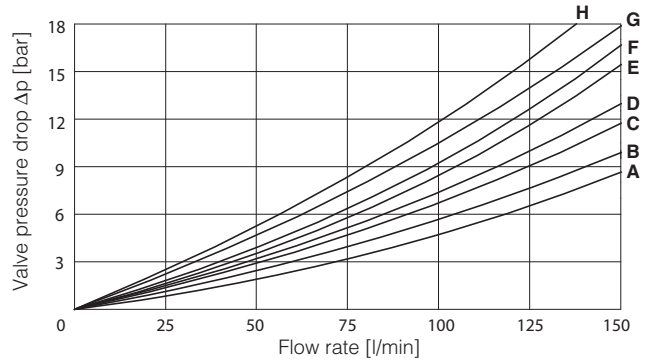

7 OPERATING LIMITS based on mineral oil ISO VG 46 at 50°C

The diagrams have been obtained with warm solenoids and power supply at lowest value ($V_{nom} - 10\%$). The curves refer to application with symmetrical flow through the valve (i.e. P→A and B→T). In case of asymmetric flow and if the valves have the devices for controlling the switching times the operating limits must be reduced.

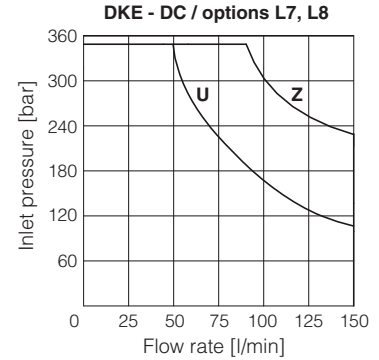
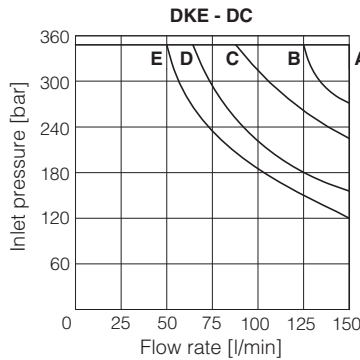
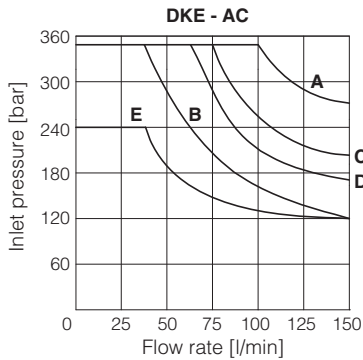

Curve	Spool type	
	AC	DC
A	0/1	0, 0/1, 1, 1/1, 3, 3/1, 1/2, 0/2, 8
B	4, 5, 19, 91	6, 7
C	0, 1/1, 3, 3/1	19, 91
D	1, 1/2, 0/2	4, 5
E	6, 7, 8, 2/2	2/2
U	-	4, 5
Z	-	0/1, 1/1, 3/1

8 SWITCHING TIMES (average values in msec)

Valve	Switch-on AC	Switch-on DC	Switch-off AC	Switch-off DC
DKE + 666 / 667	40	60	25	35
DKE + 669	60	—	90	—
DKE-*/L*	—	75÷150	—	45÷150
DKE-*/L7 - DKE-*/L8	—	100÷150	—	100÷150

Test conditions:

- 50 l/min; 150 bar
- nominal supply voltage
- 2 bar of back pressure on port T
- mineral oil ISO VG 46 at 50°C

The elasticity of the hydraulic circuit and the variations of the hydraulic characteristics and temperature affect the response time.

9 SWITCHING FREQUENCY

Valve	AC (cycles/h)	DC (cycles/h)
DKE + 666 / 667	7200	15000

10 DEVICES FOR SWITCHING TIME CONTROL

These devices are only available for DC valve version (5 chambers body) and can control the switching time and therefore reduce the coil hammering in the hydraulic circuit. The different types are available shown in the figure.

- **L**: controls and regulates the switching time in both moving directions of the spool: regulation is carried out by screwing/unscrewing the element itself (regulating choke);
- **L1/L2/L3**: controls the switching time in both moving directions of the spool by means of fixed calibrated restrictor (gauged flow). The restrictor is positioned in the valve's body $\varnothing L1 = 1,25$ mm; $\varnothing L2 = 1$ mm; $\varnothing L3 = 0,75$ mm;
- **LR**: controls and regulates the switching time in the B→A direction of the spool movement. The device does not control the switching time (standard time) in the opposite direction A→B of the spool movement.
- **L7/L8**: controls the switching time in both moving directions of the spool by means of fixed calibrated restrictor (gauged flow). The restrictor is installed in the solenoid's anchor.

For a correct operation of the switching time control, the passage in which the control device is installed must be completely filled with oil.

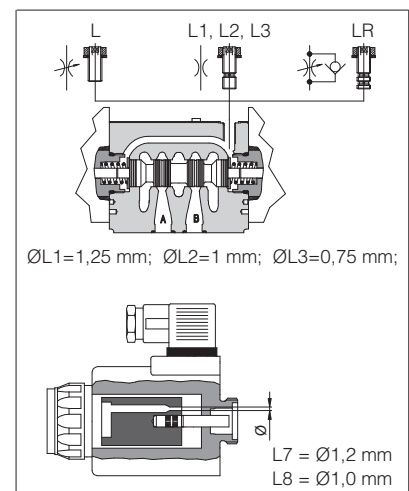

11 COILS TYPE CAE WITH SPECIAL CONNECTORS (only for 12DC, 14DC, 24DC and 28DC)

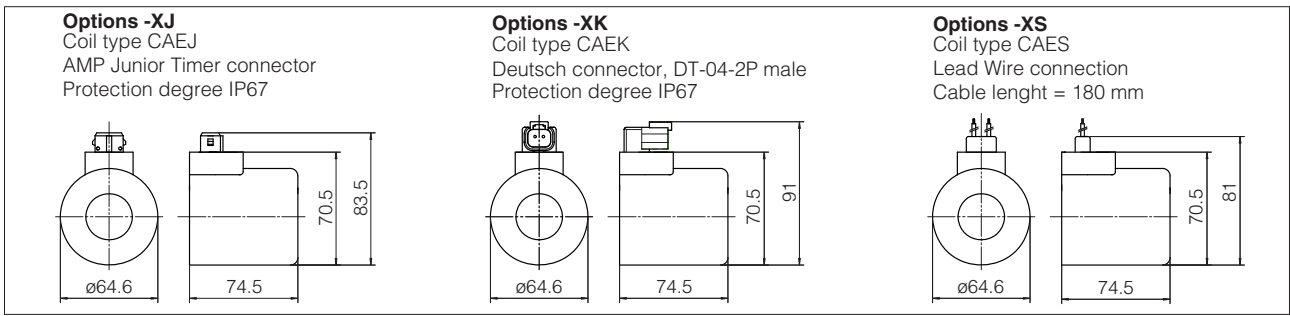

12 INSTALLATION DIMENSIONS [mm]

ISO 4401: 2005
Mounting surface according to 4401-05-05-0-05
(without X port, Y port optional)
Fastening bolts:
4 socket head screws M6x40 class 12.9
Tightening torque = 15 Nm
Seals: 5 OR 2050 and 1 OR 108
Ports P,A,B,T: Ø = 11.5 mm (max)
Ports Y: Ø = 5 mm

P = PRESSURE PORT
A, B = USE PORT
T = TANK PORT
Y = DRAIN PORT (only for option /Y)
For the max pressures on ports, see section 3

DKE-16*-AC

Option /WP

Mass: 3,9 kg

DKE-17*-AC

Mass: 4,7 kg

DKE-16*-DC

Option /WP

Mass: 4,5 kg

DKE-17*-DC

Mass: 6,1 kg

① Standard manual override PIN. The manual override operation can be possible only if the pressure at T ports is lower than 50 bar

Ⓥ Option L, L1, L2, L3, LR

13 ELECTRIC CONNECTORS ACCORDING TO DIN 43650 (to be ordered separately, see tech table K800)

- 666** = standard connector IP-65, suitable for direct connection to electric supply source
- 667** = as 666, but with built-in signal led. Available for power supply voltage 24 AC or DC, 110 AC or DC, 220 AC or DC
- 669** = with built-in rectifier bridge for supplying DC coils by alternate current (AC 110V and 230V - I_{max} 1A)

14 MOUNTING SUBPLATES

Model		Ports location	GAS Ports A-B-P-T (X-Y)	Ø Counterbore [mm] A-B-P-T (X-Y)	Mass [kg]
BA-308	(/Y)	Ports A, B, P, T (X, Y) underneath	1/2" (1/4")	30 (21,5)	2,5
BA-428	(/Y)	Ports A, B, P, T (X, Y) underneath	3/4" (1/4")	36,5 (21,5)	5,5
BA-434	(/Y)	Ports P, T, (X, Y) underneath; ports A, B on lateral side	3/4" (1/4")	36,5 (21,5)	8,5

The subplates are supplied with 4 fastening bolts M6x40. Also available are multi-station subplates and modular subplates. For further details see table K280.