

FLUKE®

930/931

Tachometer

Users Manual

English

PN 4971074
January 2009, Rev. 2, 5/18

© 2009-2018 Fluke Corporation. All rights reserved. Specifications are subject to change without notice. All product names are trademarks of their respective companies.

LIMITED WARRANTY AND LIMITATION OF LIABILITY

Each Fluke product is warranted to be free from defects in material and workmanship under normal use and service. The warranty period is one year and begins on the date of shipment. Parts, product repairs, and services are warranted for 90 days. This warranty extends only to the original buyer or end-user customer of a Fluke authorized reseller, and does not apply to fuses, disposable batteries, or to any product which, in Fluke's opinion, has been misused, altered, neglected, contaminated, or damaged by accident or abnormal conditions of operation or handling. Fluke warrants that software will operate substantially in accordance with its functional specifications for 90 days and that it has been properly recorded on non-defective media. Fluke does not warrant that software will be error free or operate without interruption.

Fluke authorized resellers shall extend this warranty on new and unused products to end-user customers only but have no authority to extend a greater or different warranty on behalf of Fluke. Warranty support is available only if product is purchased through a Fluke authorized sales outlet or Buyer has paid the applicable international price. Fluke reserves the right to invoice Buyer for importation costs of repair/replacement parts when product purchased in one country is submitted for repair in another country.

Fluke's warranty obligation is limited, at Fluke's option, to refund of the purchase price, free of charge repair, or replacement of a defective product which is returned to a Fluke authorized service center within the warranty period.

To obtain warranty service, contact your nearest Fluke authorized service center to obtain return authorization information, then send the product to that service center, with a description of the difficulty, postage and insurance prepaid (FOB Destination). Fluke assumes no risk for damage in transit. Following warranty repair, the product will be returned to Buyer, transportation prepaid (FOB Destination). If Fluke determines that failure was caused by neglect, misuse, contamination, alteration, accident, or abnormal condition of operation or handling, including overvoltage failures caused by use outside the product's specified rating, or normal wear and tear of mechanical components, Fluke will provide an estimate of repair costs and obtain authorization before commencing the work. Following repair, the product will be returned to the Buyer transportation prepaid and the Buyer will be billed for the repair and return transportation charges (FOB Shipping Point).

THIS WARRANTY IS BUYER'S SOLE AND EXCLUSIVE REMEDY AND IS IN LIEU OF ALL OTHER WARRANTIES, EXPRESS OR IMPLIED, INCLUDING BUT NOT LIMITED TO ANY IMPLIED WARRANTY OF MERCHANTABILITY OR FITNESS FOR A PARTICULAR PURPOSE. FLUKE SHALL NOT BE LIABLE FOR ANY SPECIAL, INDIRECT, INCIDENTAL, OR CONSEQUENTIAL DAMAGES OR LOSSES, INCLUDING LOSS OF DATA, ARISING FROM ANY CAUSE OR THEORY.

Since some countries or states do not allow limitation of the term of an implied warranty, or exclusion or limitation of incidental or consequential damages, the limitations and exclusions of this warranty may not apply to every buyer. If any provision of this Warranty is held invalid or unenforceable by a court or other decision-maker of competent jurisdiction, such holding will not affect the validity or enforceability of any other provision.

930/931 Tachometer

CONTENTS

Introduction	1
Safety	1
Symbols	2
Included Accessories	2
The Keypad	2
The Display	3
Operation	4
Configuration (Fluke 931)	4
Optical (Non-Contact)	4
Contact (Fluke 931)	4
Surface Speed and Length (Fluke 931)	5
Contact Wheel Use (Fluke 931)	5
Max, Min and Av Readings	5
Maintenance	6
Replacing the batteries	6
Cleaning	6
Specifications	6
RPM	6

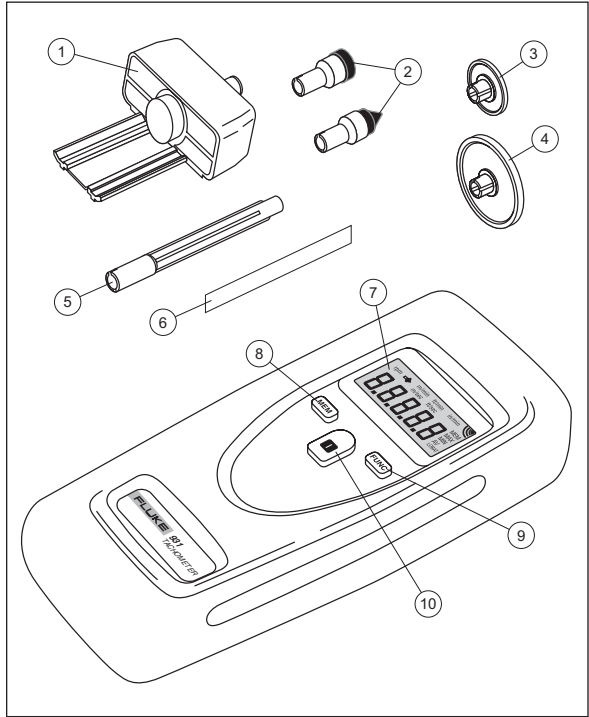

Feature	930	931	Feature	930	931
① Mechanical Adapter		●	⑥ Reflector Strip	●	●
② Shaft Contacts		●	⑦ Display	●	●
③ Contact wheel 0.1 m		●	⑧ Memory key	●	●
④ Contact wheel 6 inch		●	⑨ Function key	●	●
⑤ Shaft Extension		●	⑩ ON key	●	●

INTRODUCTION

The Fluke 930 Tachometer and the Fluke 931 Tachometer (the Tachometer) are hand-held instruments that accurately measure rotational Revolutions Per Minute (RPM). The Fluke 931 measures surface speed as well as length. Use the red beam function to make non-contact RPM measurements. The Fluke 931 uses the mechanical adapter and selectable tip to make contact RPM measurements. The Memory function allows storing the maximum (MAX), minimum (MIN), average (AV), and last reading.

SAFETY

A **Warning** identifies the conditions and procedures that are dangerous to the user.







Warning

To prevent possible electrical shock, fire, or personal injury:

- Carefully read all instructions.
- Read all safety information before you use the Product.
- Use the Product only as specified, or the protection supplied by the Product can be compromised.
- Do not use the Product around explosive gas, vapor, or in damp or wet environments.
- Do not use and disable the Product if it is damaged.
- Replace the batteries when the low battery indicator shows to prevent incorrect measurements.
- Remove the batteries if the Product is not used for an extended period of time, or if stored in temperatures above 50 °C. If the batteries are not removed, battery leakage can damage the Product.
- Do not use the Product if it operates incorrectly.
- Do not wear loose clothing when making measurement around moving machinery.

SYMBOLS

The following symbols are used on the Product and in this manual.



Symbol	Description
	WARNING.RISK OF DANGER.
	Consult user documentation.
	Battery or battery compartment.
	Conforms to relevant South Korean EMC Standards.
	Conforms to relevant Australian Safety and EMC standards.
	Conforms to European Union directives.
	This product complies with the WEEE Directive marking requirements. The affixed label indicates that you must not discard this electrical/electronic product in domestic household waste. Product Category: With reference to the equipment types in the WEEE Directive Annex I, this product is classed as category 9 "Monitoring and Control Instrumentation" product. Do not dispose of this product as unsorted municipal waste.

INCLUDED ACCESSORIES

The following accessories are included with the Tachometer:

Accessories	930	931
0.1 m Contact Wheel		●
6 in Contact Wheel		●
Cone Shaft Contact		●
Internal Cone Shaft Contact		●
Shaft Extension		●
10 Reflective Strips	●	●

THE KEYPAD

Key	Description
	Selects MAX, MIN, AV, and last reading
	Turns ON the Tachometer and makes selections. The Tachometer turns OFF after 30 seconds of inactivity.
	Selects the Measurement function

THE DISPLAY

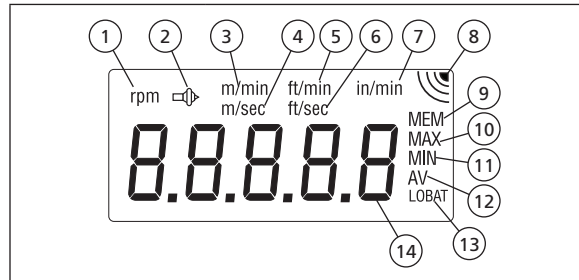

Item	930	931	Description
①	●	●	Optical RPM measurement
②		●	Contact RPM measurement
③		●	Meters per minute
④		●	Meters per second
⑤		●	Feet per minute
⑥		●	Feet per second
⑦		●	Inches per minute
⑧	●	●	Trigger display
⑨	●	●	Memory, last stored reading
⑩	●	●	Memory, maximum reading
⑪	●	●	Memory, minimum reading
⑫	●	●	Memory, average reading
⑬	●	●	Low battery indicator
⑭	●	●	Numerical reading



OPERATION

Press  to power up the Tachometer. The display test illuminates all LCD segments for 1 second and then shows the configured surface speed selection.

- The last selected mode appears at when the Tachometer is turned ON.
- The Tachometer automatically turns OFF after 30 seconds of inactivity.



CONFIGURATION (FLUKE 931)

To configure the Tachometer for the correct contact wheel used for surface speed measurements:

1. Turn ON the Tachometer.
2. Press  and  release.
3. Use  to select 0.1 (0.1 m circumference small wheel) or 6" (6 inch circumference large wheel). A 12" wheel is not available.



OPTICAL (NON-CONTACT)

To measure RPM using the non-contact red beam, remove the mechanical adapter from the top of Tachometer. Pull the adapter straight out to remove. See Figure 2.

1. Stop the rotating device to measure.
2. Clean a spot for the reflective strip.
3. Place reflective strip on rotating device.
4. Turn ON the Tachometer.
5. On the Fluke 931 use  to select RPM.
6. Aim Tachometer at rotating reflective strip keeping within 500 mm (20 inches).
7. Press  to enable the red beam.
8. When the Tachometer is triggered by the reflective strip, the trigger symbol on the display flashes and RPM will be displayed.

CONTACT (FLUKE 931)

To use the Tachometer for contact measurement, insert the mechanical adapter into top of the Tachometer, see Figure 1:

1. To measure, connect the cone or internal cone shaft contact to the end of the shaft.
2. Turn ON the Tachometer and use  to select RPM .
3. Press  to take measurements.
4. When the Tachometer is triggered, the trigger symbol flashes and the RPM is displayed.

SURFACE SPEED AND LENGTH (FLUKE 931)

Surface speed and length can be measured using the mechanical adapter and contact wheel.

	Range	
	0.1 m circumference small wheel	6 inch circumference large wheel
m/min	0.10 to 1999	0.10 to 1524
ft/min	0.40 to 6550	0.40 to 5000
in/min	4.0 to 78700	4.00 to 60000
m/sec	0.10 to 33.30	0.10 to 25.40
ft/sec	0.10 to 109	0.10 to 83.33
m	0 to 99999	0 to 99999
ft	0 to 99999	0 to 99999
in	0 to 99999	0 to 99999

CONTACT WHEEL USE (FLUKE 931)

1. Insert mechanical adapter into the top of the Tachometer. See Figure 1.
2. Select either the 0.1 m or 6 in contact wheel to use.
3. Set the Tachometer to 0.1 m or 6 in setting for the contact wheel in use.
4. Use **FUNC** to select units of measure.
5. Contact wheel to surface to measure and press **MEM** to take measurements.
6. When the Tachometer is triggered, the trigger symbol flashes and the measurement is displayed.

MAX, MIN, AND AV READINGS

Press **MEM** to enable MAX, MIN, and AV readings stored in memory. Each time a new measurement is taken, the maximum, minimum, average, and last value are stored. The last value is shown under MEM. The units of measure for the stored readings will also be displayed. Press **MEM** to exit the memory display mode.

MAINTENANCE

Beyond replacing the batteries, do not attempt to repair or service the Product unless you are qualified to do so and have relevant calibration, performance test, and service instructions. The recommended calibration cycle is 12 months.

Warning

To prevent possible electrical shock, fire, or personal injury:

- Repair the Product before use if the battery leaks.
- Use only specified replacement parts.
- Have an approved technician repair the Product.
- Be sure that the battery polarity is correct to prevent battery leakage.

REPLACING THE BATTERIES

Replace the batteries when the low battery symbol appears on the display.

1. Remove the battery cover on back of the Tachometer. See Figure 3.
2. Replace with 2 AA 1.5V IEC LR6 (Alkaline) batteries.
3. Replace the battery cover.

CLEANING

Periodically wipe the case with a damp cloth and mild detergent. Do not use abrasives or solvents. Dirt or moisture in the terminals can affect readings.

SPECIFICATIONS

RPM

	Range
Optical (non-contact)	1 RPM to 99999 RPM
Contact (Fluke 931)	1 RPM to 19999 RPM

Accuracy	±0.02 % of reading ±1 digit
Sensing Distance (optical)	500 mm (20 inches)
Battery Type	2x AA 1.5 V IEC LR6 (Alkaline)
Battery Life	Fluke 930 approximately 35 hours Fluke 931 approximately 40 hours
Operating Temperature	0 °C to +50 °C (32 °F to 122 °F)
Storage Temperature	-20 °C to +70 °C (0 °F to 160 °F)
Operating Humidity	10 %-90 % RH (non-condensing)
Operating Altitude	2000 m

Weight 250 g (0.55 lbs)
Size 175 x 60 x 28 mm (7 x 2.5 x 1 inch)

Electromagnetic compatibility (EMC)

International IEC 61326-1:Portable; CISPR 11:Group 1, Class A.

Group 1: Equipment has intentionally generated and/or uses conductively-coupled radio frequency energy that is necessary for the internal function of the equipment itself.

Class A: Equipment is suitable for use in all establishments other than domestic and those directly connected to a low voltage power supply network which supplies buildings used for domestic purposes.

Korea (KCC) Class A Equipment (Industrial Broadcasting & Communication Equipment)

Class A: Equipment meets requirements for industrial electromagnetic wave equipment and the seller or user should take notice of it. This equipment is intended for use in business environments and not to be used in homes.

Note: Serial number of the Tachometer is located in battery compartment.

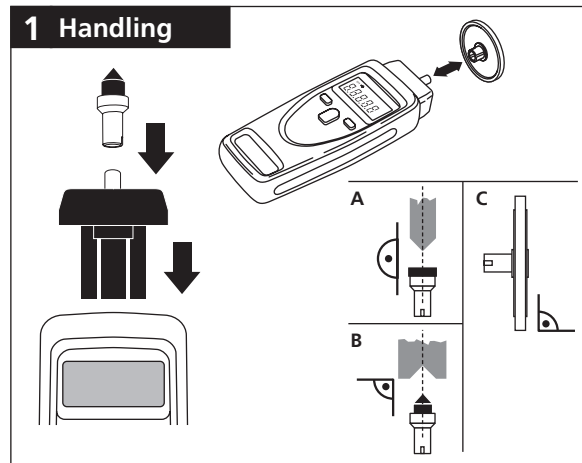

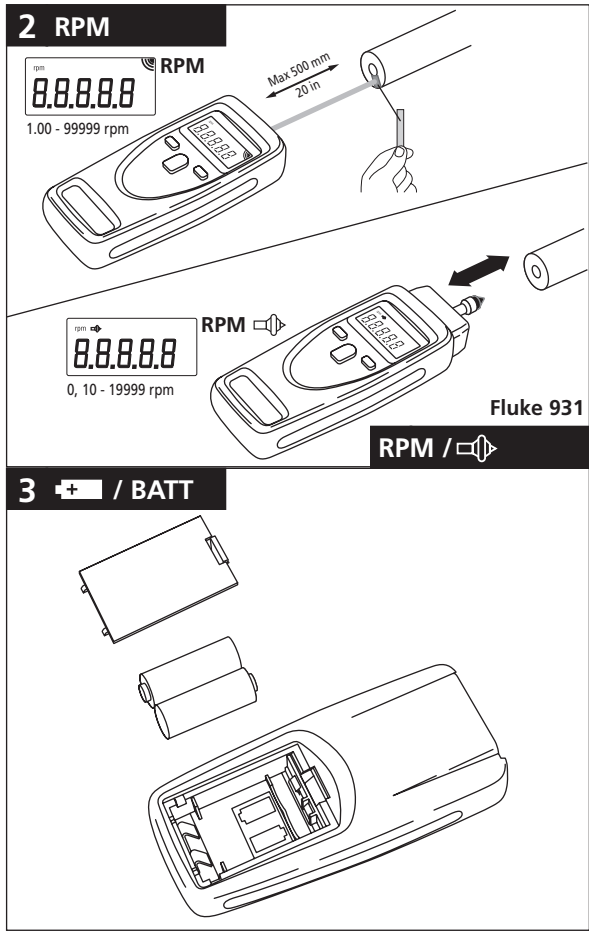

3 / BATT

